

Acumen Model J

Fireplace Remote Control Operating Instructions For The Homeowner

The Acumen Model J Remote Control is designed for use with decorative gas fireplace and wall heaters using a Millivolt gas valve.

BEFORE YOU BEGIN:

Warning: The pilot flame must be lit, with the gas control valve turned to "ON", for the remote to work correctly.

Read all of the safety precautions in the owner's manual included with your fireplace before using this remote control. The thermostat is not intended for unattended use.

INSTALLING FRESH BATTERIES:

Note: It is not necessary to re-set your private code when installing fresh batteries.

The fireplace **MUST** be OFF before replacing transmitter batteries.

INSTALL BATTERIES INTO RECEIVER:

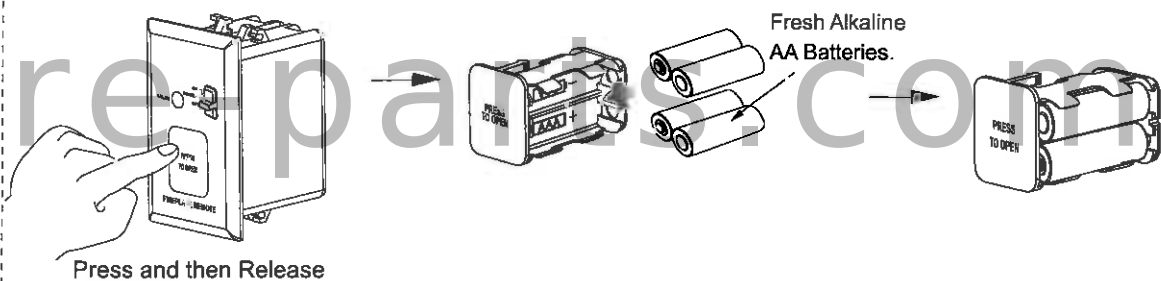

INSTALL BATTERIES INTO TRANSMITTER:

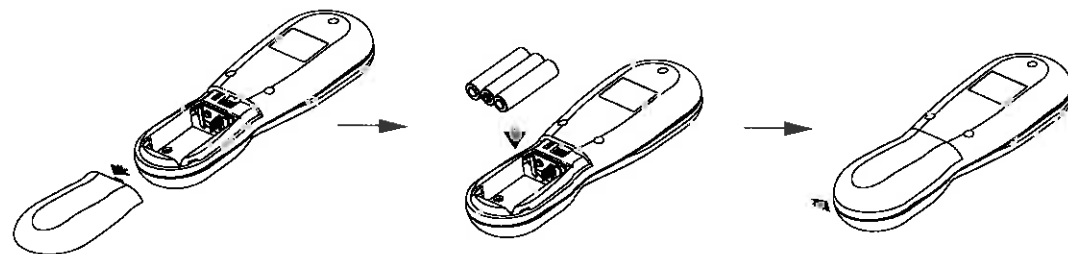

Change Batteries At Least Every 6 Months:

WARNING: THE REMOTE TRANSMITTER WILL AUTOMATICALLY SWITCH OFF THE FIREPLACE WHEN THE BATTERIES IN THE REMOTE TRANSMITTER ARE LOW.

RECEIVER OPERATION:

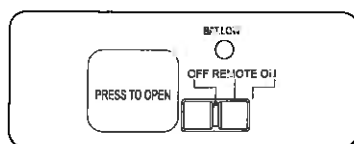

Fireplace Off

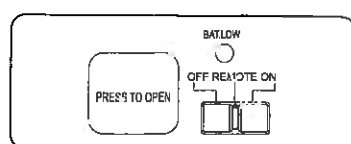

Fireplace Controlled
by Remote

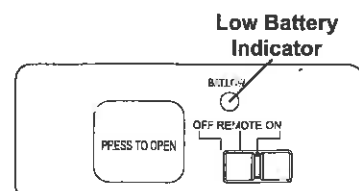

Fireplace On

TRANSMITTER OPERATION:

IMPORTANT NOTES:

The fireplace will automatically shut off after 6 hours of Continuous operation.

- Press the On button once to turn On the fireplace.
- Press the Off button once to turn Off the fireplace.

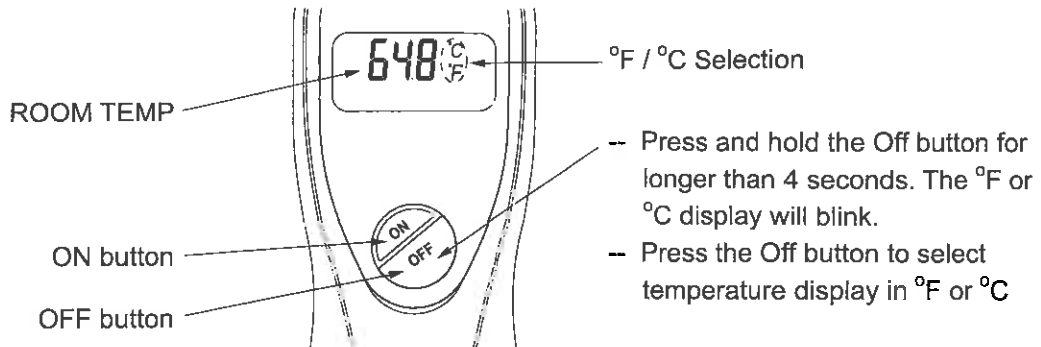

WARNING: IT TAKES SOME TIME FOR THE RECEIVER TO RESPOND TO THE TRANSMITTER. DO NOT PRESS THE ON/OFF BUTTONS MORE THAN ONCE WITH 2 SECONDS FOR CORRECT OPERATION.

fire-parts.com

CHILD-PROOF FEATURE:

The Child-Proof switch disables the buttons on the front of the Remote.

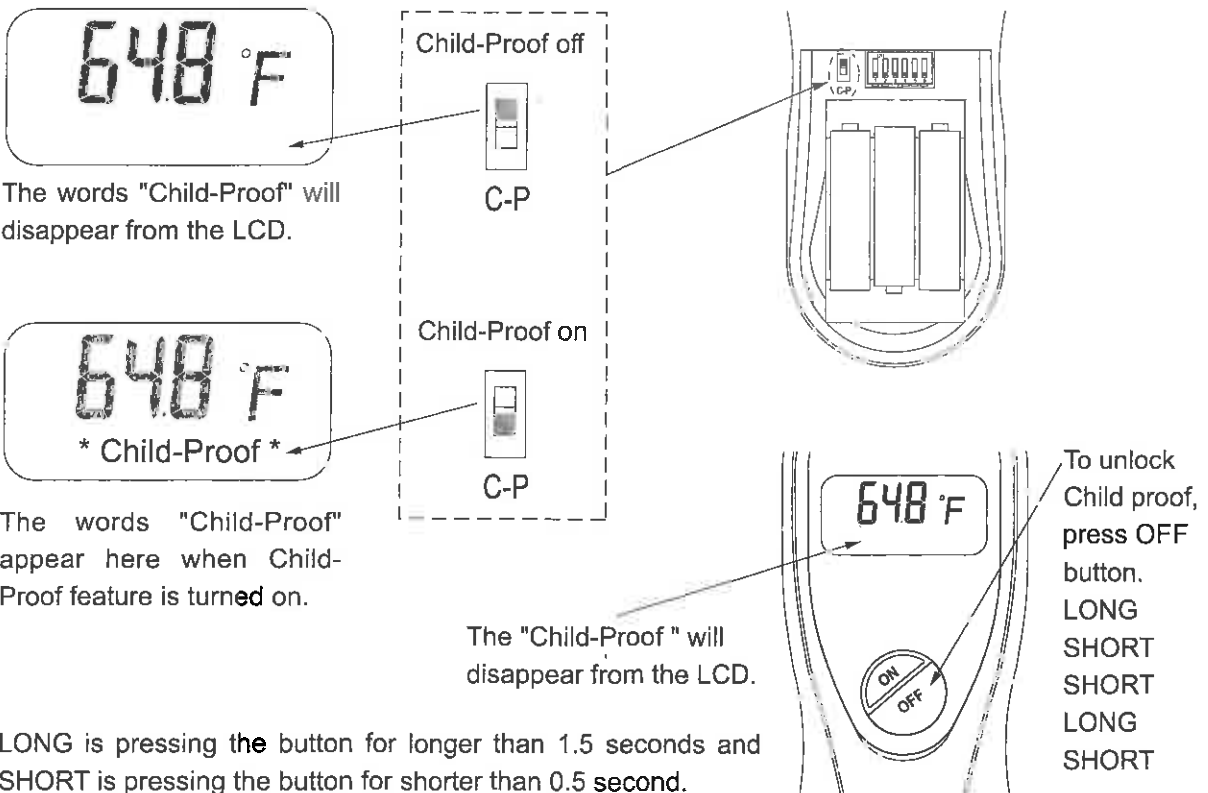

LONG is pressing the button for longer than 1.5 seconds and SHORT is pressing the button for shorter than 0.5 second.

SET PRIVATE CODE:

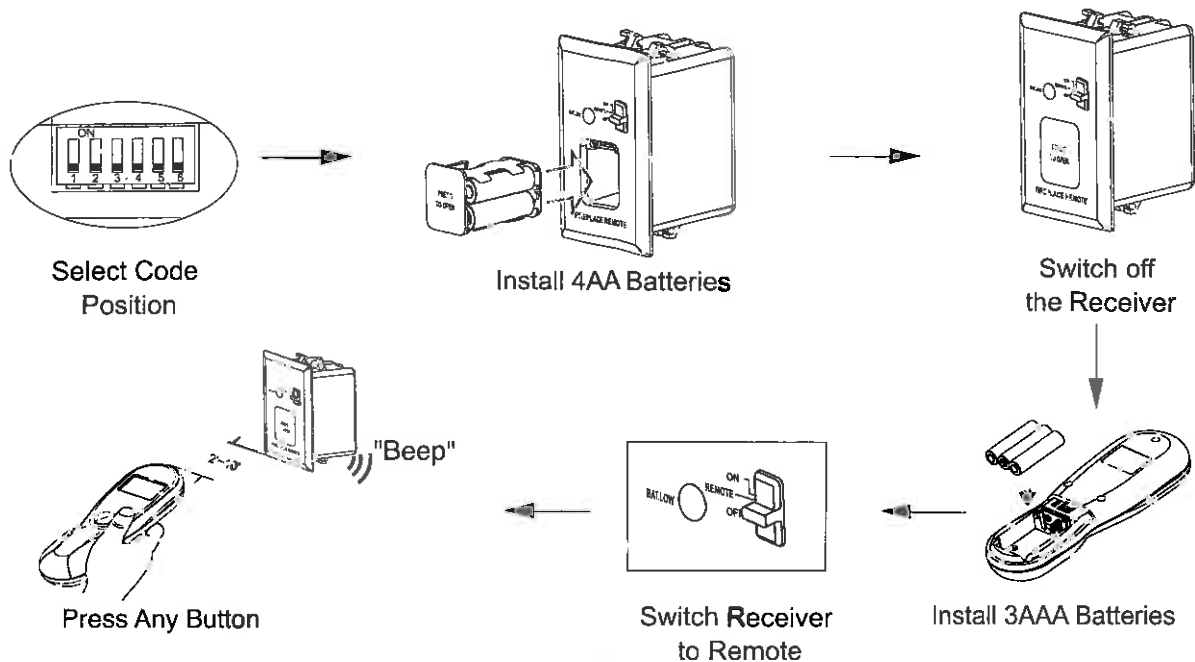

FCC Requirements

Warning: Changes or modifications to this unit not expressly approved by the party responsible for compliance could void the user authority to operate the equipment. This equipment has been tested and found to comply with the limits for a Class B digital device, pursuant to Part 15 of the FCC Rules. These limits are designed to provide reasonable protection against harmful interference in a residential installation. This equipment generates, uses, and can radiate radio frequency energy and, if not installed and used in accordance with the instructions, may cause harmful interference to radio communications. However, there is no guarantee that interference will not occur in a particular installation. If this equipment does cause harmful interference to radio or television reception, which can be determined by turning the equipment off and on, the user is encouraged to try to correct the interference by one or more of the following measures:

- Reorient or relocate the receiver antenna.
- Increase the separation between the equipment and receiver.
- Connect the equipment into an outlet on a circuit different from that to which the receiver is connected.
- Consult the dealer or an experienced radio TV technician for help.

Canadian Equipment Requirements

This digital apparatus does not exceed the (class A/Class B)* limits for radio noise emissions from digital apparatus set out in the Radio Interference Regulations of the Canadian Department of Communications. Le présent appareil numérique n'émet pas de bruits radioélectriques dépassant les limites applicables aux appareils numériques (de la class A/de la class B)* prescrites dans le Règlement sur le brouillage radioélectrique édicté par le ministère des Communications du Canada.

This device complies with RSS-210 of Industry and Science Canada. Operation is subject to the following two conditions: (1) this device may not cause interference, and (2) this device must accept any interference, including interference that may cause undesired operation of the device.

All wiring should be done by a qualified electrician and shall be in compliance with local codes and with the National Electric Code ANSI/NFPA No. 70-current (in the United States), or with the current CSA C22.1 Canadian Electric Code (in Canada).

Acumen Model J

Fireplace Remote Control Installation Instructions

PLEASE LEAVE THE INSTRUCTIONS TO THE HOMEOWNER.

The Acumen Model J Remote Control is designed for use with decorative gas fireplace and wall heaters using a millivolt gas valve.

The Model J Transmitter is a Two-button hand held transmitter, which turns the gas on/off. The display of the transmitter shows the current room temperature, low battery indicator and "Child-Proof".

Installation Precautions:

The Model J Remote Control is tested safe when installed in accordance with this installation manual. It is your responsibility to read all instructions before starting installation and to follow these instructions carefully during installation.

The Model J Remote Control **MUST** be installed by a qualified service technician.

The Model J Remote Control is carefully engineered and **MUST** be installed only as specified. If you modify it or any of its components, you may possibly cause a fire hazard.

Installation Instruction

1.0 Installing the Receiver

1. Make sure the slide switch on the Remote Receiver is at the OFF position.
2. Connect the wires to the TH and TPTH terminals of the Millivolt valve. See *Figure 1*.

3. Installing the Remote Receiver to a Wall Mount:

- Secure the Remote Receiver to the wall mount.
- Use the screws provided to secure the face blade to the Remote Receiver. See *Figure 2*.

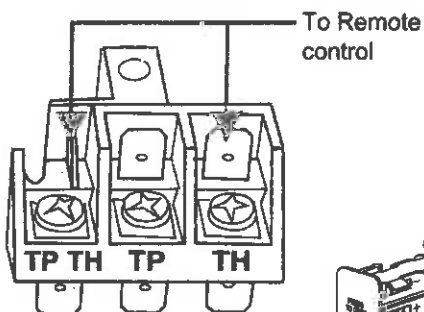

Figure 1

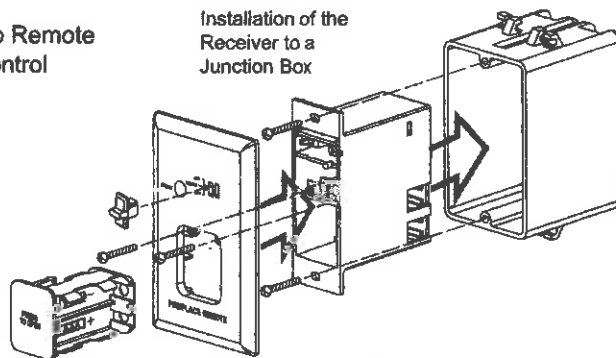

Figure 2

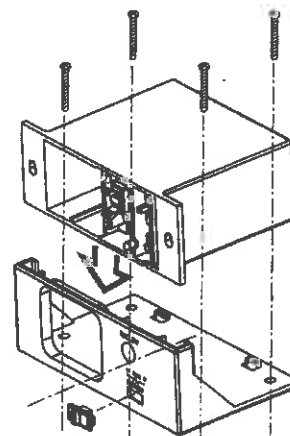

Figure 3

4. Installing the Remote Receiver to a Fireplace:

- Secure the Fireplace Mounting plate to the base pan of the fireplace.
- Slide the Remote Receiver into the fireplace mounting plate. See *Figure 3*.

5. Put the switch cap to the slide switch.

6. Slide the battery compartment into the Remote Receiver. See *Figure 4*.

7. In order to prevent the Remote Receiver (fireplace installation only) from overheating, put a heat shield (option item) above the Remote Receiver. See *Figure 5*.

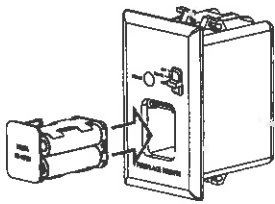

Figure 4

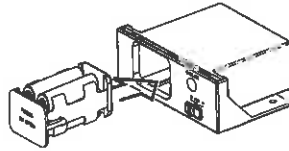

Figure 5

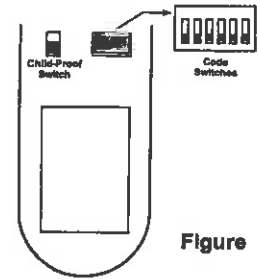

Figure 6

2.0 IMPORTANT SAFETY FEATURE:

You can set a private code into your system to prevent accidental operation by another transmitter nearby. See *Figure 6*.

2.1 Coding Instructions:

1. Remove the cover on the back of the Remote Transmitter to expose the code switches. Slide the code switches to your choice of ON or OFF positions. **FACTORY SETTING IS ALL "OFF"**.
2. Make sure the slide switch on the Remote Receiver is at OFF position.
3. Keep the Remote Transmitter and the Remote Receiver within 2-10 feet.
4. Slide the slide switch on the Remote Receiver to REMOTE position.
5. Install fresh AAA alkaline batteries into the Remote Transmitter.
6. Press any button on the Remote Transmitter, the Remote Receiver will produce a 'beep' sound when it receives the code from the Remote Transmitter.
7. If you do not hear a 'beep' sound from the Remote Receiver, remove the batteries from the Remote Transmitter and slide the slide switch on the remote receiver to OFF position, Wait for 1 minute, and repeat step 2 to 6.
8. Replace the cover of the Remote Transmitter and the Receiver. The system is now ready to operate.

FCC Requirements

Warning : Changes or modifications to this unit not expressly approved by the party responsible for compliance could void the user authority to operate the equipment. This equipment has been tested and found to comply with the limits for a Class B digital device, pursuant to Part 15 to the FCC Rules. These limits are designed to provide reasonable protection against harmful interference in a residential installation. This equipment generates, uses, and can radiate radio frequency energy and, if not installed and used in accordance with the instructions, may cause harmful interference to radio communications. However, there is no guarantee that interference will not occur in a particular installation. If this equipment does cause harmful interference to radio or television reception, which can be determined by turning the equipment off and on, the user is encouraged to try to correct the interference by one or more of the following measures:

- Reorient or relocate the receiver antenna.
- Increase the separation between the equipment and receiver.
- Connect the equipment into an outlet on a circuit different from that to which the receiver is connected.
- Consult the dealer or an experienced radio TV technician for help.

Canadian Equipment Requirements

This digital apparatus does not exceed the (class A/Class B)* limits for radio noise emissions from digital apparatus set out in the Radio Interference Regulations of the Canadian Department of Communications. Le présent appareil numérique n'émet pas de bruits radioélectriques dépassant les limites applicables aux appareils numériques (de la class A/de la class B)* prescrites dans le Règlement sur le brouillage radioélectrique édicté par le ministère des Communications du Canada.

This device complies with RSS-210 of Industry and Science Canada. Operation is subject to the following two conditions: (1) this device may not cause interference, and (2) this device must accept any interference, including interference that may cause undesired operation of the device.

All wiring should be done by a qualified electrician and shall be in compliance with local codes and with the National Electric Code ANSI/NFPA No. 70-current (in the United States), or with the current CSA C22.1 Canadian Electric Code (in Canada).

Fireplace Remote Control Installation Instructions

PLEASE LEAVE THE INSTRUCTIONS TO THE HOMEOWNER.

6HR SAFETY TIMER

Enable - Timer Set to "ON"

In case of Transmitter failure (Malfunction / Battery run out), The Receiver will shut down the fireplace automatically after 6Hr of no Transmitter signal detection.

Disable - Timer Set to "OFF"

The Receiver & Fireplace will continue to operate in the last setting and will not shut off automatically in case of Transmitter failure.

(Note: Not recommended)

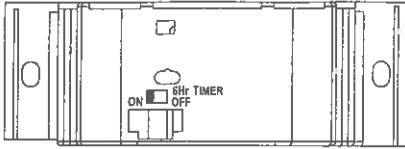

(Low Profile DC Receiver)

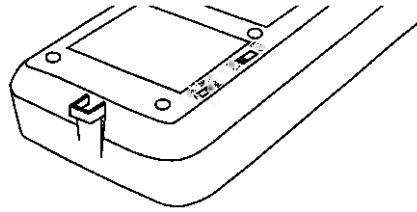

RX-07(AC)

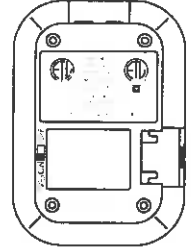

RX-04(AC)

	First 2Hr since last signal received	Following 4Hr	6 th Hr since last signal received
Receiver/Fireplace Status	ON	Alternate OFF (30min) / ON (20min), check for Tx signal	Shut down if no signal received